



SMARTSIM

DL FACTORY BUILDER

FACTORY DESIGN AND AUTOMATION









DE LORENZO

3D FACTORY SIMULATOR FOR LEARNING AUTOMATION WITH PLC

The DL FACTORY BUILDER is a software that has been developed to teach factory design, industrial automation, and PLC programming in a unique and effective way.

With this software, students can improve their individual experience on studying industrial automation in practice.

Students will be able to develop several projects dealing with the following topics:

-  Design and implementation of production lines including equipment, sensors, actuators, conveyor systems and so on;
-  Develop PLC projects for production line equipment;
-  Develop PLC projects for material flow management;
-  Study automation basics, PLC, sensors and actuators;
-  Study automation strategies such as state machines, interlocks, control strategies and advanced control;
-  Study robotics;
-  Study basic and advanced PLC programming.

This software works integrated to a SoftPLC (not included) which can be the Siemens PLCSIM or Codesys Control, as well as it can be connected to a real Siemens S7-1200/1500 or other PLC with Modbus/TCP interface.

INDUSTRIAL
PLC PROGRAMMING TOOLS

POWERFUL
3D SIMULATOR

PROFESSIONAL
LEARNING

INDUSTRIAL REALISTIC
ENVIRONMENTS

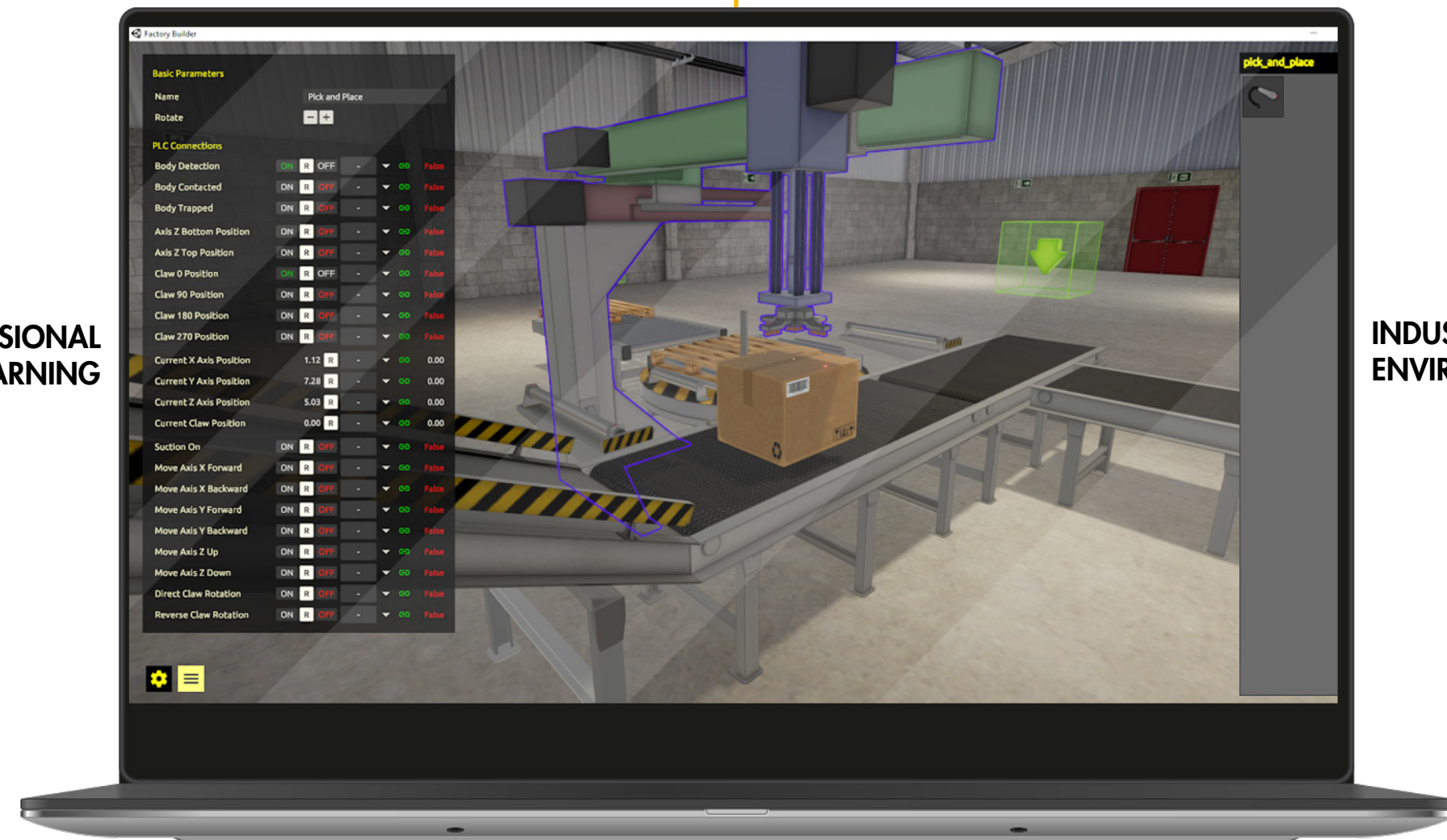

PROFESSIONAL EXPERIENCE

REAL SITUATIONS

SEVERAL EQUIPMENT, SENSORS AND ACTUATORS AVAILABLE, AND MUCH MORE COMING SOON ON THE UPDATES!

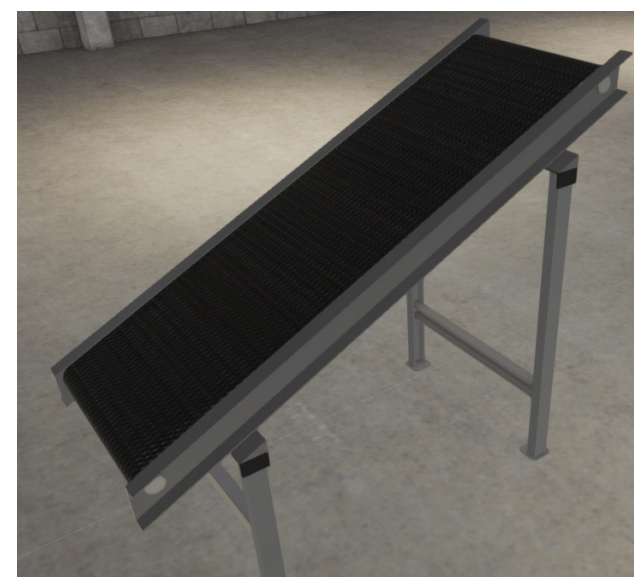
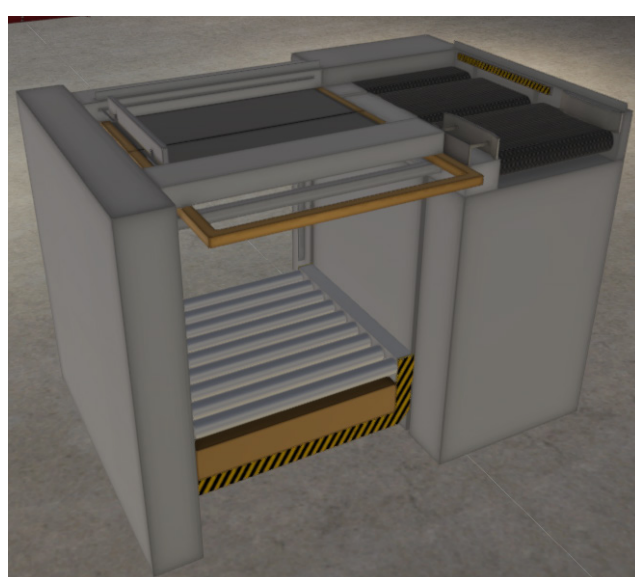
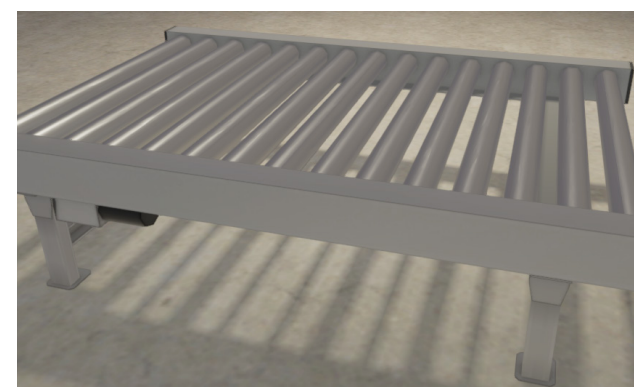
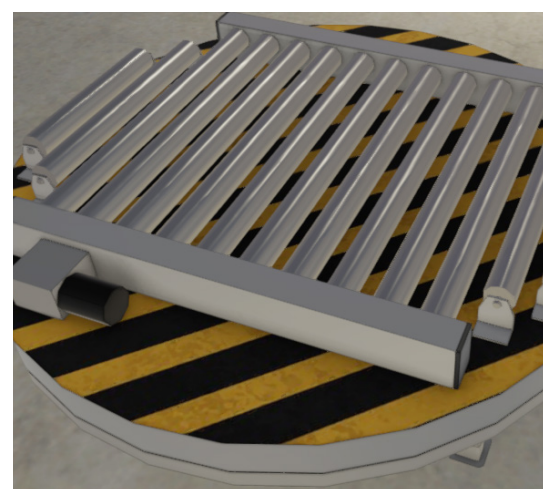
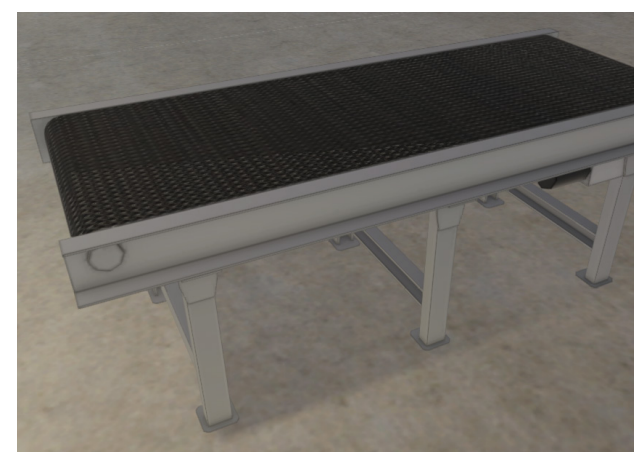
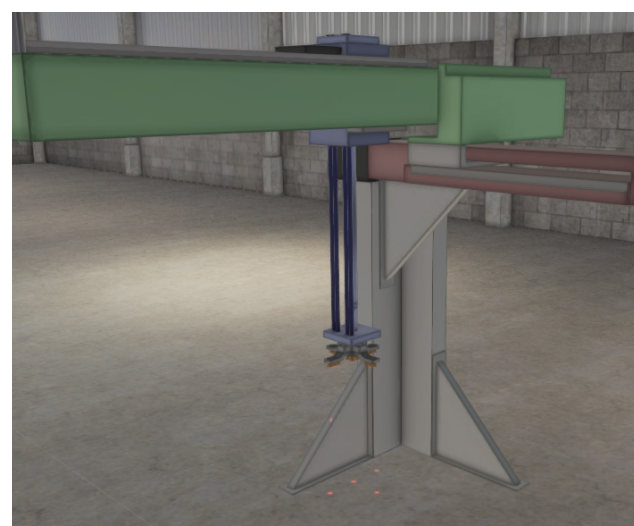

EQUIPMENT, SENSORS AND ACTUATORS (AVAILABLE AND COMING SOON!)

EQUIPMENT

- SEVERAL CONVEYORS
- PALLETIZER
- ELEVATOR
- TRANSELEVATOR
- WEIGHT CONVEYOR
- INK COLORING SYSTEM
- PICK-AND-PLACE
- ROBOT

SENSORS

- OPTICAL
- INDUCTIVE
- CAPACITIVE
- SCALE
- DISTANCE
- LEVEL
- TEMPERATURE
- PRESSURE
- FLOW
- ROTARY ENCODERS

ACTUATORS

- PNEUMATIC PISTON
- MOTORS
- PUMPS
- VALVES

SUMMARY OF FEATURES

IT'S A 3D SIMULATOR



YOU CAN BUILD YOUR FACTORY



YOU CAN CONTROL IT WITH A PLC OR SOFTPLC

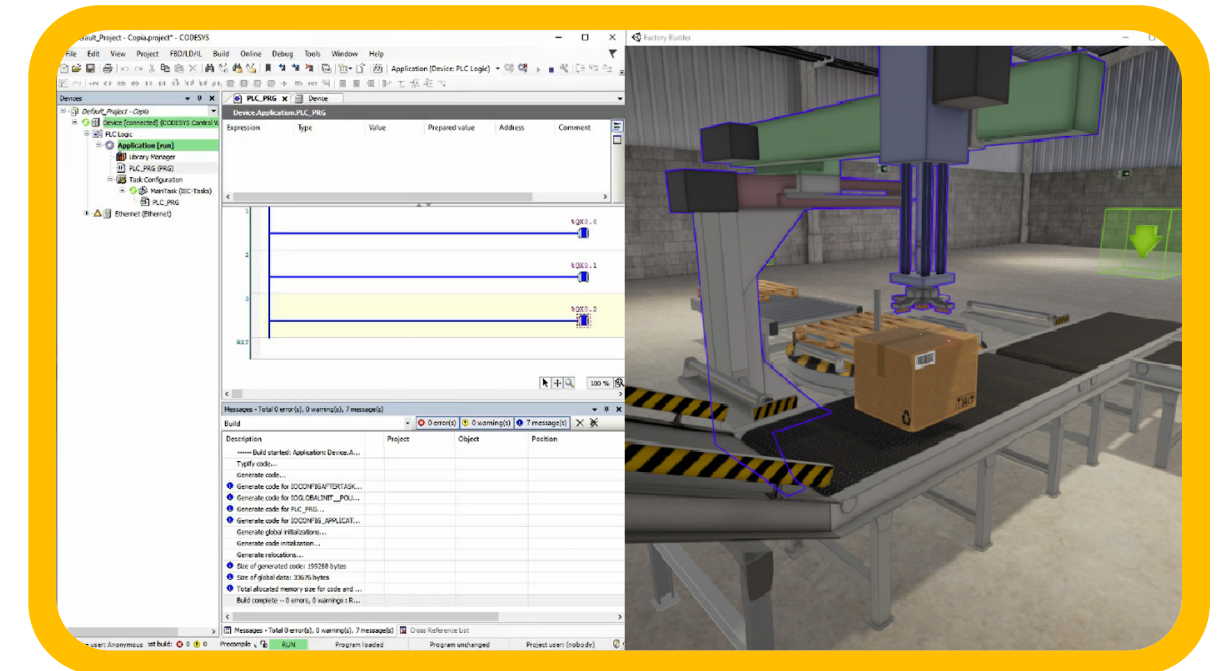

YOU CAN SAVE YOUR FACTORY AND SHARE IT WITH STUDENTS, PROFESSORS ETC



YOU CAN SIMULATE FAULTS ON SENSORS AND ACTUATORS



STUDENTS CAN LEARN AND PRACTICE FROM BASIC TO ADVANCED AUTOMATION WITH PLC

With the industrial 3D environments and the built-in projects it's possible to develop solutions that evolve basic ladder logic, analogue handling, math operations, comparisons, state machines, SFC, function blocks and a lot more.

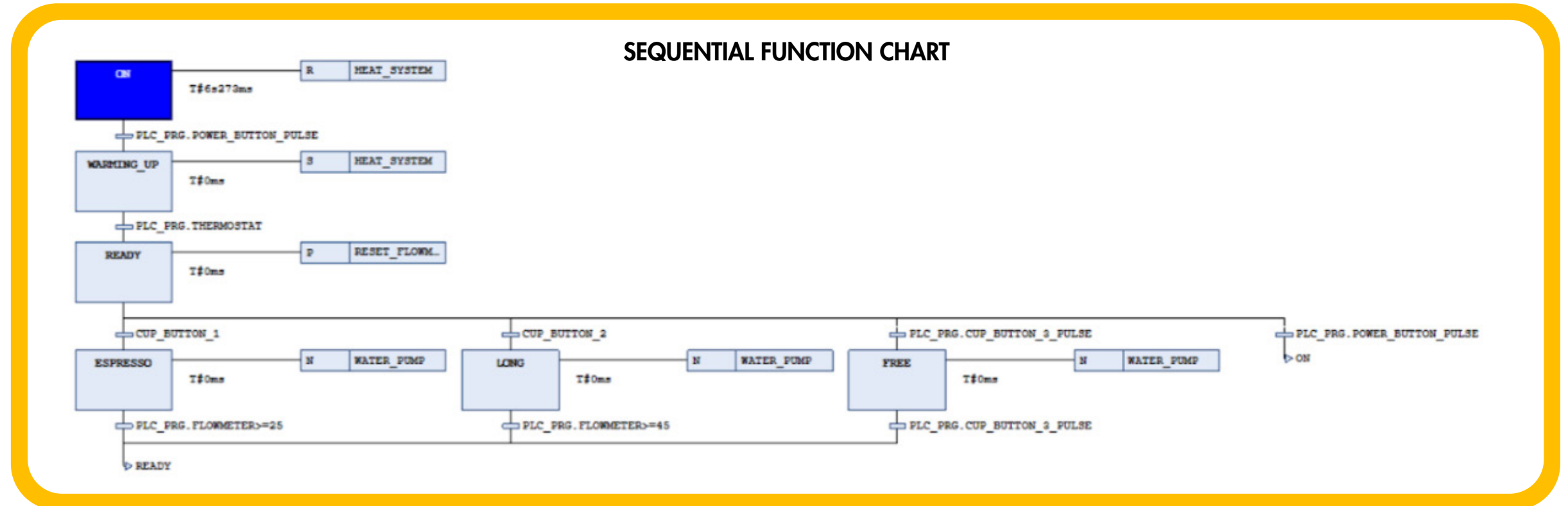
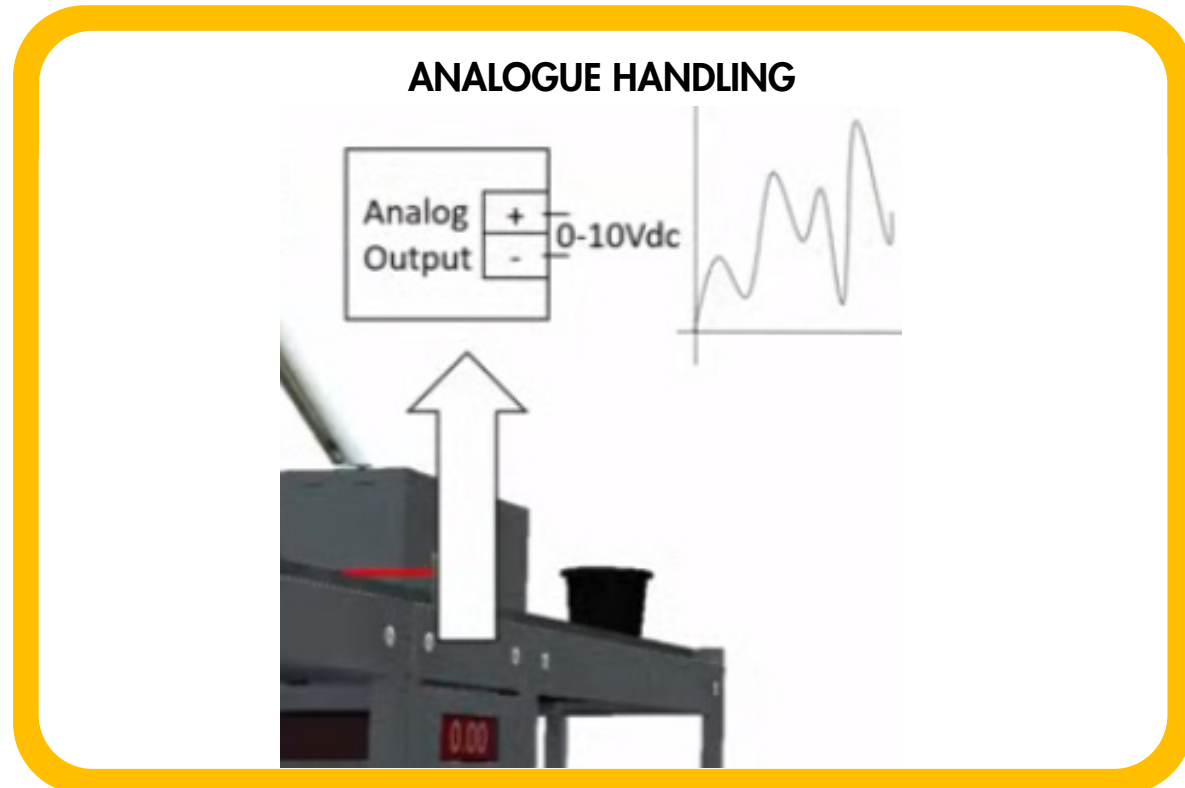
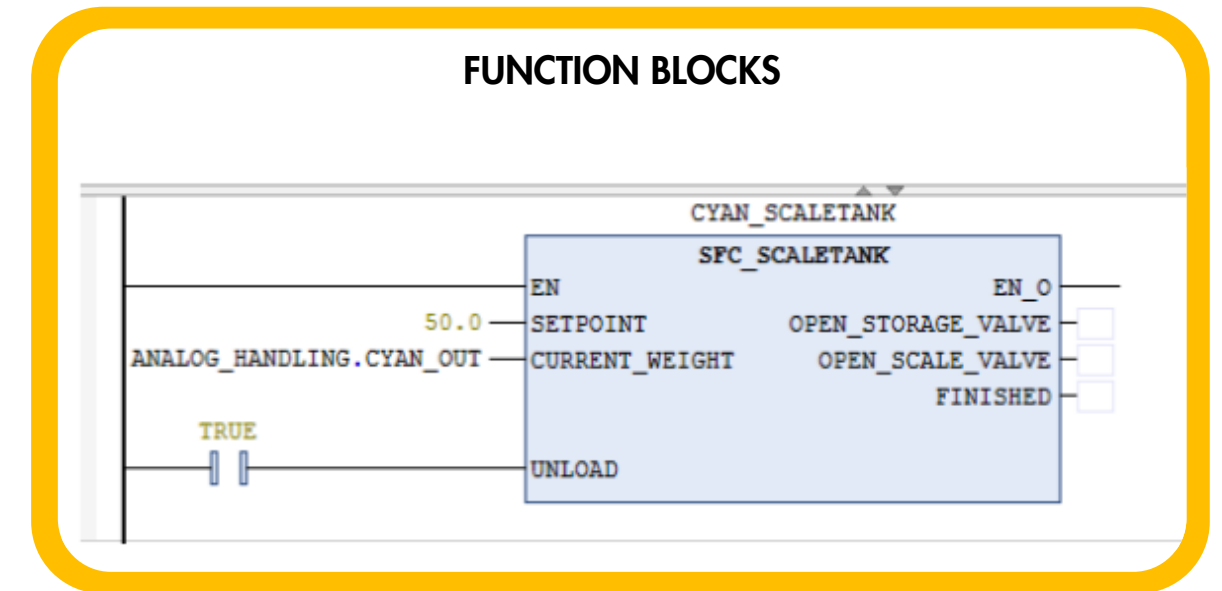
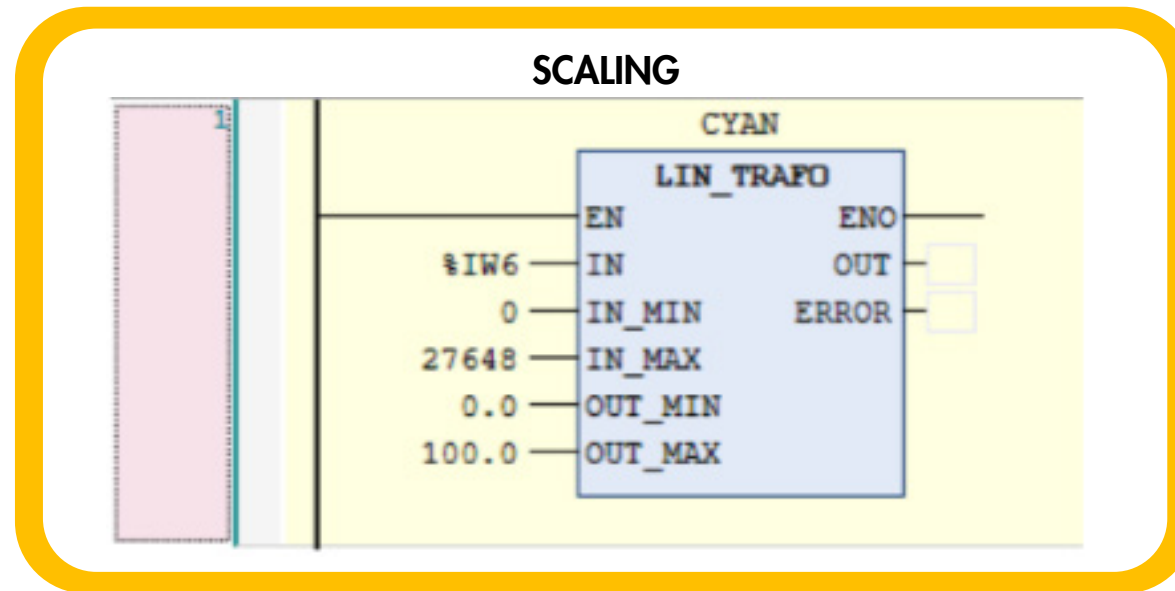
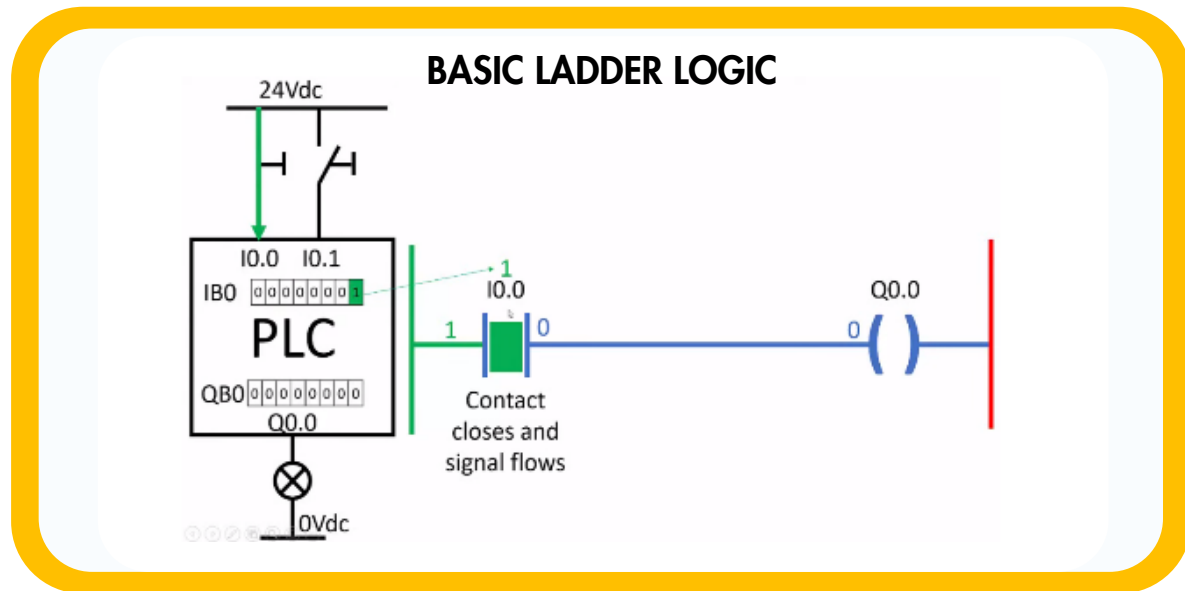

SYSTEM REQUIREMENTS

ORDER CODES

DL FACTORY BUILDER-C

CONTROL AND AUTOMATION SMARTSIM WITH DRIVER FOR CODESYS/MODBUS

DL FACTORY BUILDER-T

CONTROL AND AUTOMATION SMARTSIM WITH DRIVER FOR S71 200/1 500 AND PLCSIM

IMPORTANT NOTE:

THESE PRODUCTS DO NOT INCLUDE ANY THIRD PARTY SOFTWARES SUCH AS TIA PORTAL, PLCSIM, CODESYS OR CODESYS CONTROLWIN.

TO OUR KNOWLEDGE, CODESYS DEVELOPMENT SYSTEM CAN BE DOWNLOADED FOR FREE AT CODESYS STORE. TIA PORTAL AND PLCSIM HAVE TRIAL VERSIONS ON SIEMENS WEBSITE AND AN EDUCATIONAL VERSION CAN BE PURCHASED FROM SIEMENS.

MINIMUM REQUIREMENTS

OPERATIONAL SYSTEM

64-BIT WINDOWS 10

DIRECTX VERSION

DIRECTX 11

PROCESSOR

INTEL i5 9400F OR AMD RYZEN 5 3600

MEMORY

8GB

GRAPHIC CARD

STORAGE

HDD (1GB)

RECOMMENDED REQUIREMENTS

OPERATIONAL SYSTEM

64-BIT WINDOWS 10 PRO

DIRECTX VERSION

DIRECTX 12

PROCESSOR

INTEL i7 9700 OR AMD RYZEN 7 3700X

MEMORY

16 GB

GRAPHIC CARD

NVIDIA GTX 1050 TI 4GB OR RX 550 4GB

STORAGE

HDD (1GB)